

---

# USER MANUAL

---

1000W 208-277V DIMMABLE DE SYSTEM

---

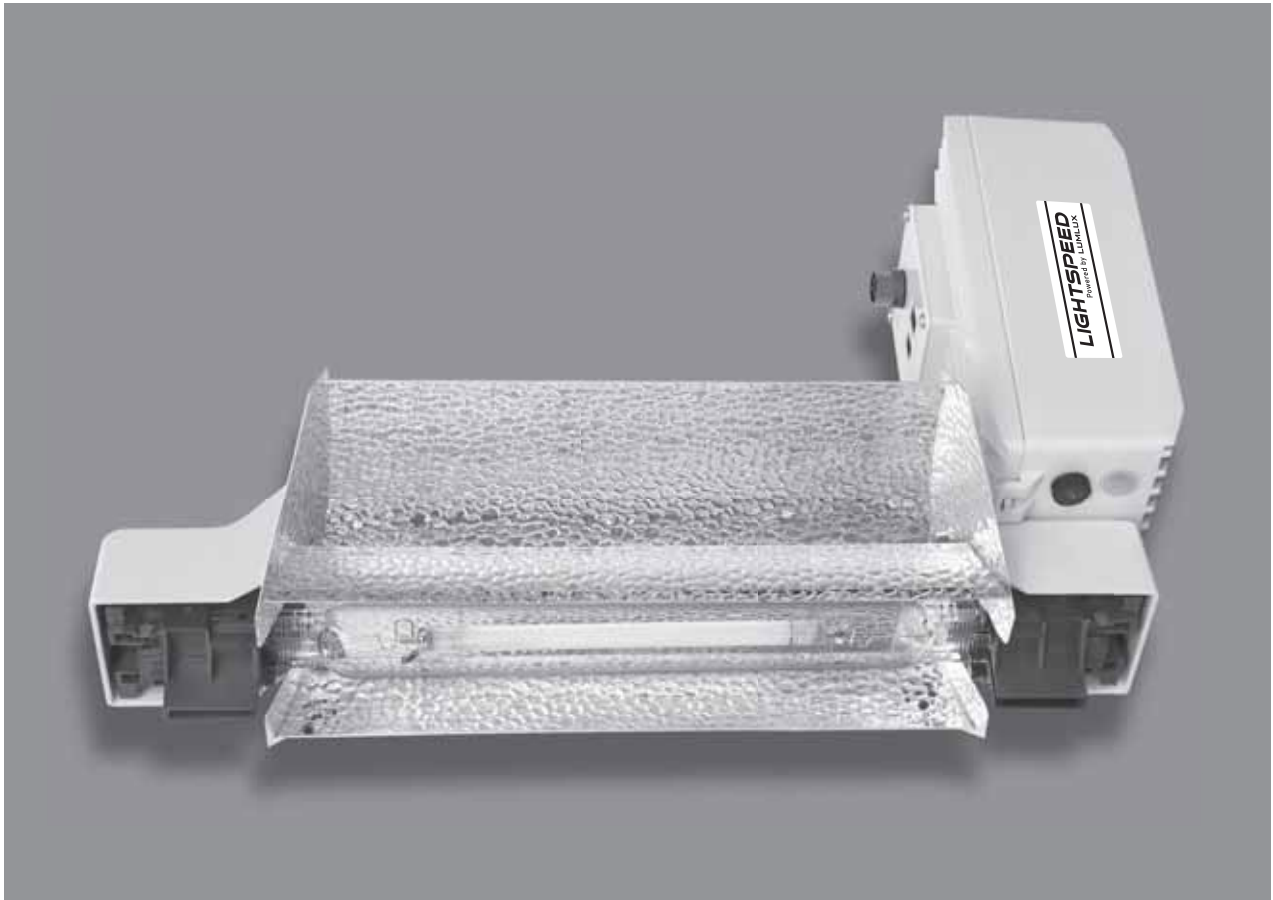

# **LIGHTSPEED**

Powered by LUMLUX

## ***Dimmable DE Lighting System***



**HYDROTEK**  
HYDROPONICS

---

# SPECIFICATIONS

## INPUT CHARACTERISTICS

Parameters	Conditions	Min	Type	Max	Units
<b>Mains Voltage</b>	Operational Voltage	187	208-277	305	V
	Safe Voltage	177	208-277	319	
<b>Mains Frequency</b> $f_{\text{mains}}$	Operational Frequency	48	50/60	63	Hz
	Safe Frequency	45	50/60	66	
<b>Mains Power</b> $P_{\text{mains}}$	P=100%	979	1030	1082	W
	P=90%	881	927	974	
	P=80%	784	825	867	
	P=70%	685	721	758	
	P=60%	588	618	649	
<b>Mains Current</b> $I_{\text{mains}}$	$V_{\text{mains}} = 277V$	3.6	3.8	4.1	A
	$V_{\text{mains}} = 208V$	4.8	5.1	5.4	
	$V_{\text{mains}} = 185V$	5.4	5.7	6.1	
<b>Power Factor</b>	P=1000W	0.97	0.98	--	--
<b>THD</b>	P=1000W	--	--	10%	--
<b>Inrush Current</b>	$V_{\text{mains}} = 277V$ $T_a = 25^\circ C$ cold start	--	--	30	A
<b>Pulse Duration</b>		--	--	0.8	ms

Note: The certified current of this product is : 6.5A(208V)/4.8A(277V).

## OUTPUT CHARACTERISTICS

Parameters	Conditions	Min	Type	Max	Units
<b>Lamp Frequency</b> $f_{\text{lamp}}$	P=1000W	110	125	135	KHz
<b>Efficiency(%)</b>	P=1000W	95	96	--	--
<b>Lamp Power</b> $P_{\text{lamp}}$	P=100%	949	1000	1052	W
	P=90%	854	900	947	
	P=80%	759	800	842	
	P=70%	664	700	737	
	P=60%	570	600	631	
<b>Lamp Voltage</b>	1000W DE	200	250	300	V
<b>Ignition Voltage</b>	$C_{\text{load}} < 100pF$	3000	4000	5000	V
<b>Ignition Interval</b>	--	1-5-5-5-5			Min

## RECOMMENDED MATCHING LAMP TYPES

1000W HPS DE

### CANDELA DISTRIBUTION

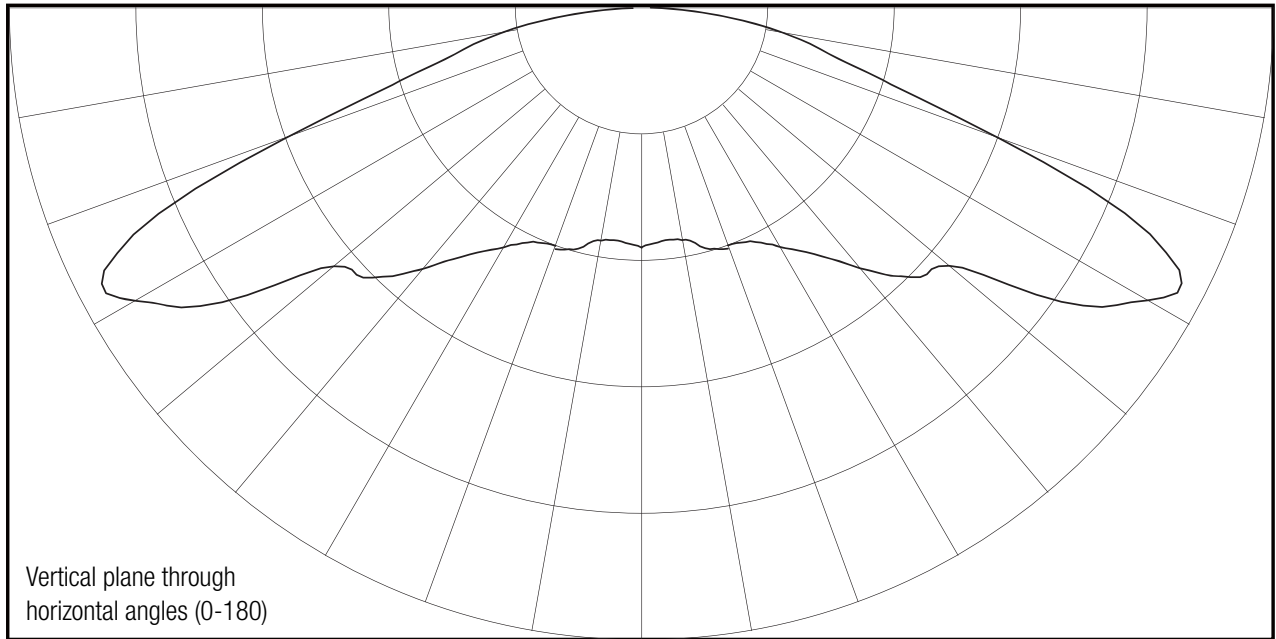

### CAUTION – RISK OF FIRE

This product must be installed in accordance with applicable national and local electrical and construction codes by a person familiar with the construction and operation of the product and the hazards involved.

**LIGHTSPEED**  
Powered by **LUMLUX**

Distributed by



[www.HydrotekHydroponics.com](http://www.HydrotekHydroponics.com)

## REMOTE DIMMING WITH OPTIONAL DIGITAL CONTROLLER

All output specifications are reported as a percentage of the full ballast rating ,  
EXP: 80% of 1000W ballast = 800W.

Output Mapping Equation (W): (Dimming ratio)\*ballast rating=Output.

Note : 1. Dimming accuracy is 3% (as per the output power of  $V_{mains} = 208V$ ).

2. When the dimming ratio is 0%, the ballast will be off ; user can set the parameters show in the 60%-100%.

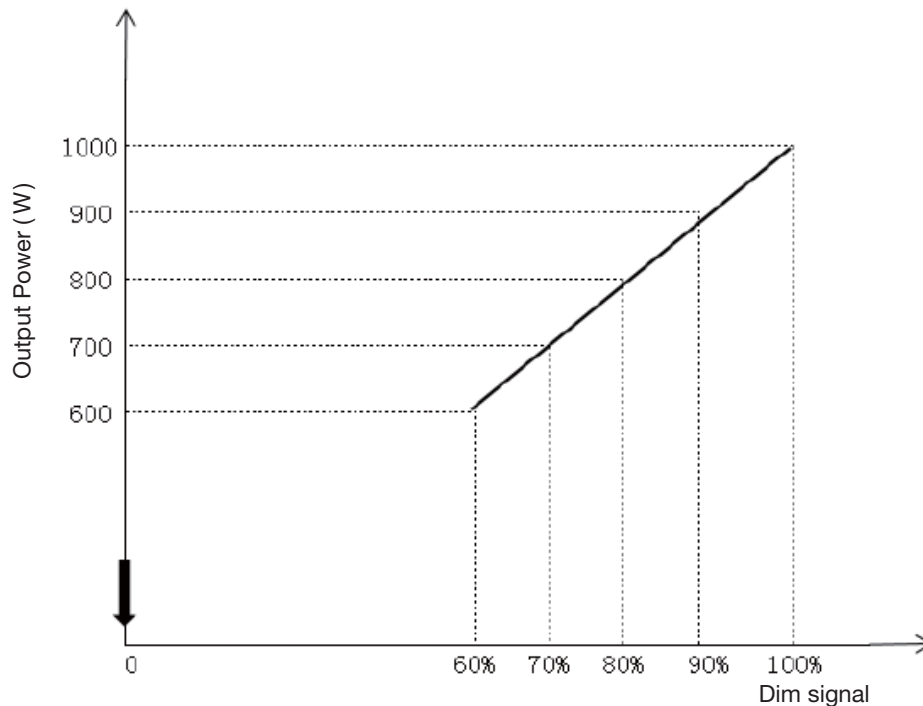

## REMOTE CONTROL FUNCTION

- It can control remotely the ballast's on/off/dimming rate.
- Group control mode: It can control the state of a set of products.
- Single lamp control mode: It can control the state of a single product.
- Sun rise and set: When the SR/SS set time is 0 min, the ballast will power on/off as its own speed, actually, it's exactly same as Power on/off.
- If no controller, the ballast can work with full power. If the controller is connected, it will work at the controller's power.

# STATUS INDICATOR

The Lightspeed 1000W DE System is equipped with an LED status indicator and an internal troubleshooting system.

- With no connected power supply, the ballast LED will be off.
- With power supply connected, the ballast LED will illuminate.

Note: When connected to the Lightspeed Digital Controller, the ballast LED status indicator will be off and instead the controller LED will be lit and flashing.

- If a system error occurs, the LED status indicator will flash abnormally. Refer to this chart to determine the signaled error:

LED Flashes	Status	Solution
1	Ballast locked	The ballast failed to ignite the lamp after five tries. Verify and reconnect the power source.
2	Output error	The lamp stopped for unknown reason. Check whether the lamp is correctly mounted.
3	Low input voltage	The input voltage is too low. Ensure the input voltage matches the power cord and ballast specifications.
4	High temperature	The ballast is overheated, to keep the environment temperature lower.
5	High input voltage	The input voltage is too high. Ensure the input voltage matches the power cord and ballast specifications.
6	Lamp error	Lamp voltage is too high or too low. Replace the lamp with the correct specifications.

## CONTENTS

1000W HPS Ballast	1	Connecting Cable With Wieland Plug	1
Double Ended Reflector	1	Hanging Hooks Set	1
Instruction Manual	1	System-to-System Signal Cable	1

## WARNING

- For indoor use only.
- Install the system in a cool, dry, well-ventilated location.
- Ensure the power source meets the specifications of the unit.
- The power cord and any extensions used must match the voltage supplied to the system and meet standard electrical safety requirements.
- Modifying or opening the system will void the warranty.
- When resetting the ballast, a 15 minutes cool down period is required between lamp ignitions.
- Wear safety glasses and gloves when installing lamp.

## IMPORTANT

- If the lamp fails to ignite:
  - Verify all electrical connections.
  - Check for errors via the LED status indicator (See instructions under "LED Status Indicator") and make the necessary correction.
- Should the fixture continue to fail, contact the point of sale for warranty and repair instructions.
- Prior authorization from Technical Support is required before opening the ballast and accessing internal components. Any unapproved attempt to open and/or repair the ballast will void the warranty.

# FIXTURE INSTALLATION

1. Screw the provided hooks into their receptacles at the top of the reflector arm and ballast.
2. Hang the system from an adequate support using chain, ratchet hangers, or other suitable cables. Allow space around all sides of the unit for sufficient airflow.
3. Attach the female end of the power cord to the male input receptacle on the ballast.
4. (Optional) Connect the unit to the advanced Digital Lighting Controller via a connecting cable, following the controller instructions. When linking multiple units, use the included connecting cable to connect ballasts.
5. Plug the male end of the power cord into a properly grounded outlet to power on the system.

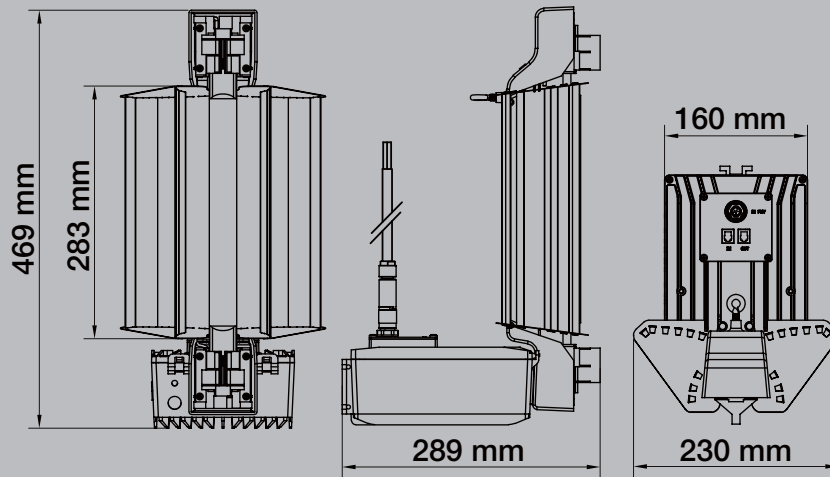

**208V**  
(Supply voltage 208V)

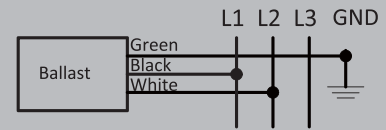

**208V**  
(Supply voltage 208V)

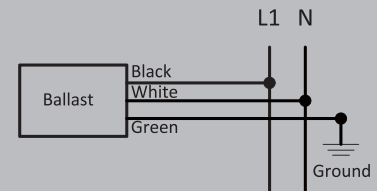

**240V**  
(Supply voltage 120V x 2)

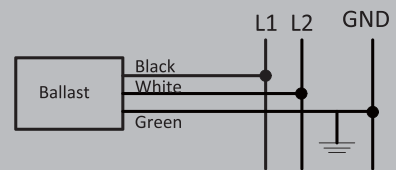

# LAMP INSTALLATION

Avoid handling the lamp with bare hands, as dirt and oils will affect its efficiency and lifespan.

- 1) Disconnect the light fixture from its power source.
- 2) Open the lamp holders by sliding them outward as shown (A).
- 3) Slide both ends of the lamp into the lamp holders until they click into place (B).
- 4) Secure the lamp in place by sliding the lamp holders back toward the center of the reflector (C).
- 5) Gently wipe the lamp clean with a soft, dry, lint-free cloth.

**277V**  
(Supply voltage 480V)

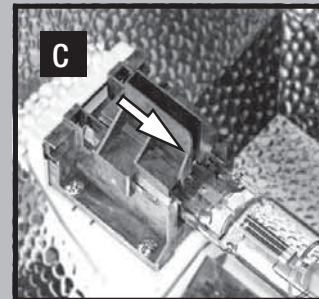
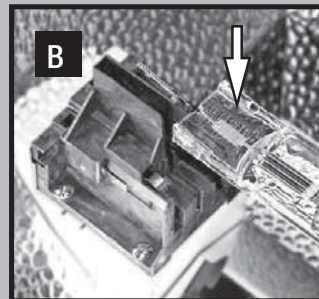
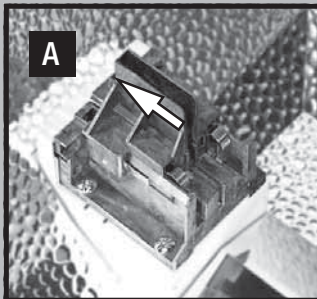
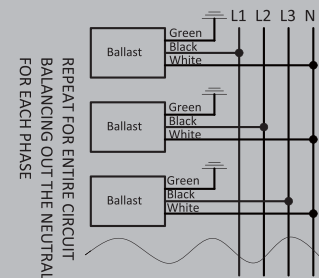

Manufactured by LUMLUX

Distributed by Hydrotek Hydroponics  
Mirabel, QC, Canada J7J 2K4  
[www.HydrotekHydroponics.com](http://www.HydrotekHydroponics.com)

